



## **KOMPATTO 221**

**TECHNICAL DATA  
SPÉCIFICATIONS PRODUIT  
ESPECIFICACION TÉCNICA**

# KOMPATTO 221

The KOMPATTO 221 Screener is a small yet robust machine designed for recycling, composting, topsoil, landscaping, and contract building industries. Its compact size, quick set-up times, ease of transport and ease of operation makes the KOMPATTO 221 the ideal solution for small scale operations.

La KOMPATTO 221 est une machine petite mais robuste conçue pour les industries du recyclage, du compostage, de la terre végétale, de l'aménagement paysager et de la construction contractuelle. Sa taille compacte, ses temps d'installation rapides, sa facilité de transport et sa facilité d'utilisation font du KOMPATTO 221 la solution idéale pour les opérations à petite échelle.

La KOMPATTO 221 es una criba compacta pero también robusta, diseñada para aplicaciones de reciclaje, compostaje, tierra vegetal, paisajismo y construcción. Su diseño compacto, y su fácil operación y transporte, convierte la criba KOMPATTO 221 en la herramienta ideal para operadores pequeños.

1. SCREEN BOX/CRIBLE/CRIBLA
2. FINE SIZE/TAPIS FINES/CINTA FINO
3. MID-SIZE/GRAIN MOYEN/CINTA MEDIO
4. POWER UNIT/MOTEUR/ACCIONAMIENTO
5. CONTROL/COMMANDE/CONTROL
6. TRACKS/CHENILLES/ORUGA





# SCREENER



# **TECHNICAL DATA**

## **SPÉCIFICATIONS PRODUIT**

## **ESPECIFICACION TÉCNICA**

**SCREEN BOX**  
**CRIBLE CAISSON**  
**CRIBLA**

2200X1100mm (10'X4')

**OUTPUT POTENTIAL UP TO**  
**PRODUCTION/RENDEMENT JUSQU'A'**  
**PRODUCCION HASTA**

80tph / 90 US tph



**POWERUNIT**

**MOTEUR**

**ACCIONAMIENTO**

Stage V: 18,5kW / 25Hp Diesel Engine

Tier 4Final: 18,5kW / 25Hp Diesel Engine

Stage 3A: 21,5kW / 28Hp Diesel Engine

**WEIGHT**

**POIDS**

**PESO**

3.300kgs (7.275lbs)

## STANDARD MACHINE

### GENERAL MACHINE

#### STANDARD

Remote control

Radio control

Remoto



## OPTION

Long fine size

Punch plate – Mesh – Mesh Arpa

Longeur tapis fines

Plaque perforée – Mailles – Grille Losange

Largo cinta medio

Planchas perforadas – Mallas – Mallas Arpa



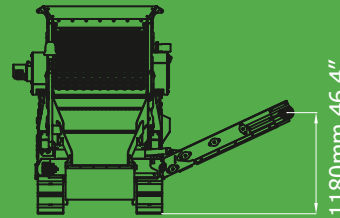
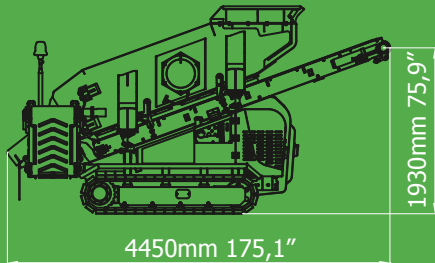
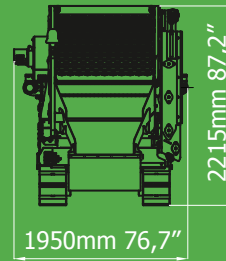
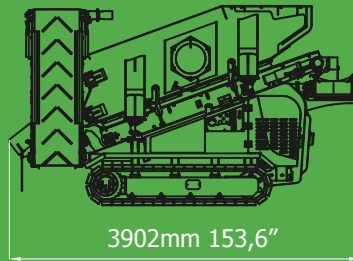
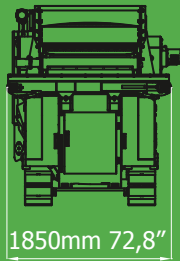
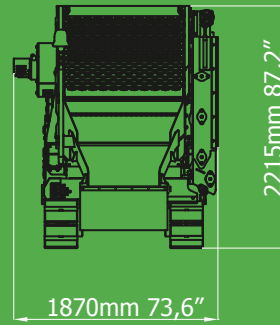
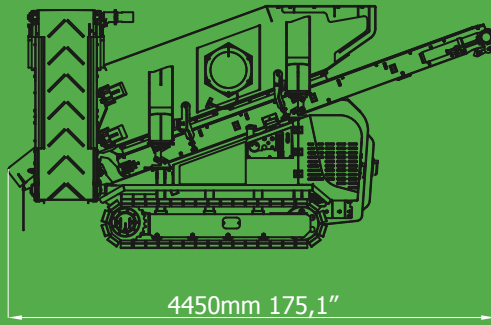

**QUICK, EASY AND SAFE TRANSPORT**  
**TRANSPORT RAPIDE, FACILE ET SÛR**  
**TRANSPORTE RÀPIDO, FACIL Y ASEGURADO**



**DEALER**

**WWW.KOMPLET.IT**  
**WWW.KOMPLETAMERICA.COM**

